

# SONOFF

## CAM Slim

User manual V1.0

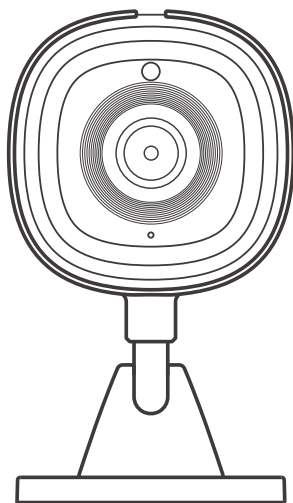

Smart Home Security Camera

## 产品介绍

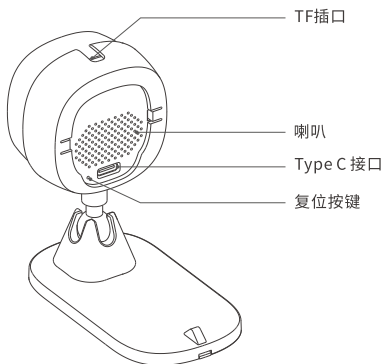
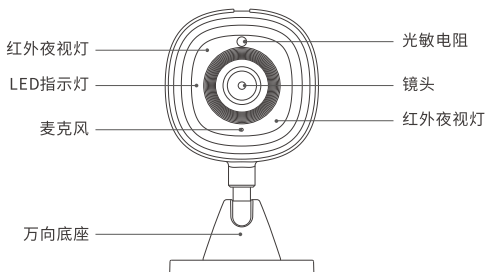

## LED指示灯状态说明

LED指示灯状态	状态说明
红色常亮	配网模式
红色慢闪	固件升级中
蓝灯常亮	设备在线
蓝灯慢闪	网络连接中 网络异常(无WiFi/无服务器连接)

## 产品特点

CAM Slim是一款轻量级的家庭安防智能监控摄像机,通过与eWeLink App连接即可实时在App端查看家里情况、远程对话、设置移动侦测消息及时推送至App以及分享给您的家人等等。

### FHD

1080P高清图像



红外夜视



双向对话



移动侦测



支持云存储  
(CN暂不支持)



报警功能



场景联动



分享功能



RTSP协议



消息推送



支持TF卡

⊕ 已安装TF卡的情况下,触发移动侦测功能时,设备除了及时消息推送至app还会自动录制30秒-5分钟短视频记录下当时的情形储存于TF卡。

⊕ 搭配使用的TF卡需要传输速率>class10

## 使用说明

### 1. 下载“易微联”App

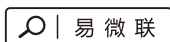

Android™ & iOS

## 2. 连接摄像机电源

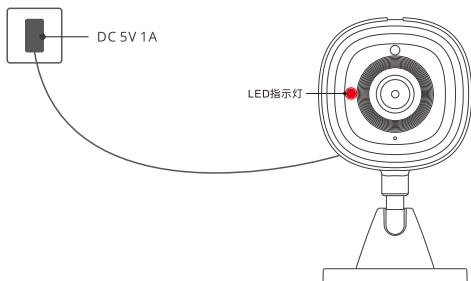

开机后,设备首次使用,默认已复位,听到“please use mobile phone for Wi-Fi configuration”语音提示,且LED指示灯呈红色常亮状态,表示摄像机进入配网模式。

⊙ 5分钟内没进行添加摄像机,摄像机将退出配网模式,如需再次进入,请长按摄像机“RESET”按键3秒直到听到“Reset success”,等待设备重启完成后,根据语音提示进行下一步操作。

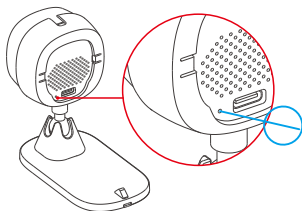

## 3. 添加摄像机



点击“+”,选择“声波配对”,再根据App提示进行操作。

## 兼容模式配网

如声波配对失败,可使用“兼容模式”配网:

将摄像机设置进入配网模式,点击eWeLink App主界面“+”,选择“兼容模式”,再根据App提示进行添加。

## 产品参数

产品型号	S-CAM
电源输入	5V=1A
接口类型	Type-C
光圈	F2.3
分辨率	1080P
视频编码	H.264
Wi-Fi	IEEE 802.11 b/g/n 2.4GHz
存储方式	云存储和TF卡 (TF卡最大支持256GB)
App支持系统	Android & iOS
工作温度	-10°C~40°C
外壳材料	ABS V0
产品规格	91x53x44.5mm

## 红外夜视

设备内置2个红外夜视灯,夜视距离高达10米。红外线在LED在弱光条件下会自动激活,确保画面在黑暗中清晰可见。

## 摄像头界面绑定

CAM Slim摄像机与 SONOFF BASIC, S26, TX, SNZB系列等设备,可在eWeLink App设备主界面快速进行摄像头界面绑定。

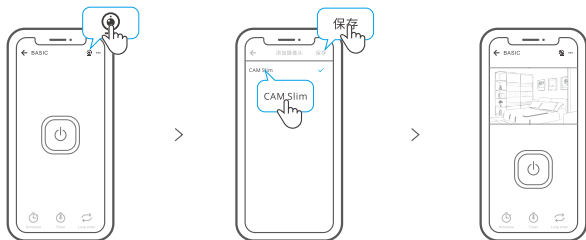

## 安装TF卡

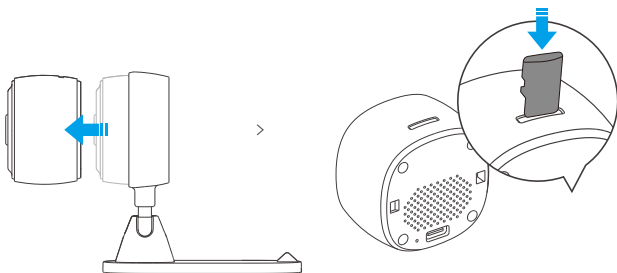

⊙ 本产品不包含TF卡, 请需另行购买

## 恢复出厂设置

在eWeLink App端“删除设备”, 设备即恢复出厂设置。

## 摄像机安装方法

- ① 桌面摆放
- ② 磁吸 (吸附在金属材质表面)
- ③ 3M胶黏贴
- ④ 螺丝固定

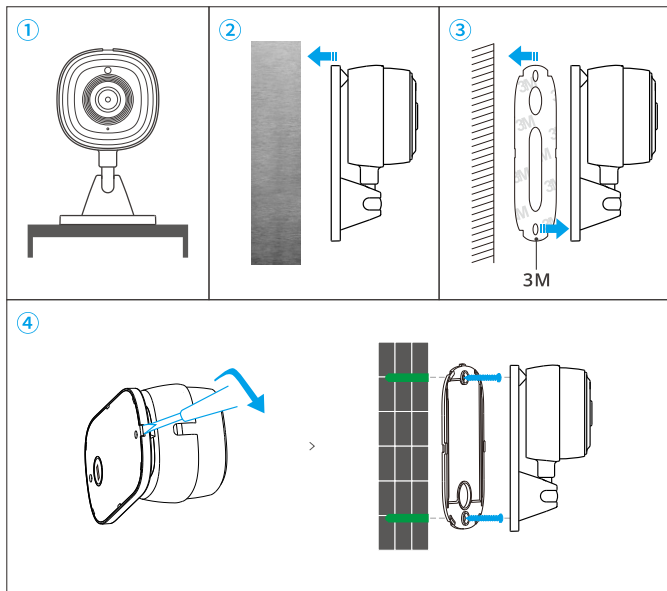

## 摄像头维护注意事项

- 摄像头不宜长时间在阳光下暴晒，严禁水进入。
- 若图像逐步模糊，可用软布沾酒精擦拭镜头，去除污渍影像即清晰。
- 摄像头喇叭报警声建议不能长期打开，报警声会吵扰周围居民，同时也会影响喇叭寿命。

## 常见问题及解决办法

问：网络连接不上，配对不成功？

答：使用WiFi连接，请检查以下事项重新添加：

- ① 检查路由器网络是否是2.4g，双频路由器关闭5g即可；
- ② 摄像头是否离路由器太远，拿近一点；
- ③ 如果周围有强电干扰，请换个环境或WiFi重新配对。

问：声音有啸叫正常吗？

答：摄像头与手机靠的太近开启Speak（对讲功能），摄像头音频和手机音频会互相干扰，发出干扰的声音，这并不影响使用，请将手机与摄像头的距离拉长便可消除干扰。

问：手机与摄像头对讲的时候摄像头为什么没有声音？

答：用手机说话的时候要把对讲的按钮打开，如果是手机听不到摄像头的声音，要把手机上面禁音的图标打开。

问：报警功能怎么设置？

答：点击已添加设备的“右上角圆圈”的标志，进入摄像头的设置界面，点击“移动侦测”，选择需要的灵敏度，有“高/中/低”三种可以选择，然后把报警联动提示音打开，监控画面检测到有移动的物体就会发出报警。

问：图像卡顿是什么问题？

答：摄像头需要一定的上传宽带维持一个稳定的连接，推荐摄像头所处网络上行宽带2M以上，手机所处网络下行宽带建议2M以上，若摄像头接入的是WiFi，WiFi使用人较多也会导致图像卡顿，建议摄像头插网线试试。

问：移动侦测误报？

答：移动侦测是摄像头检测画面是否有变化，如果有变化报警，并不是检测到有人的时候才报警，光线、树影、飞行的动物等都会触发摄像头报警，避免这些问题的办法是把移动侦测报警的灵敏度调到“低”。



## Product Introduction

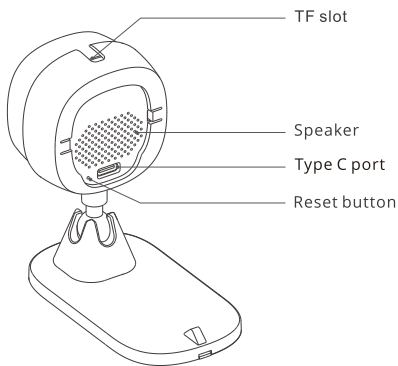
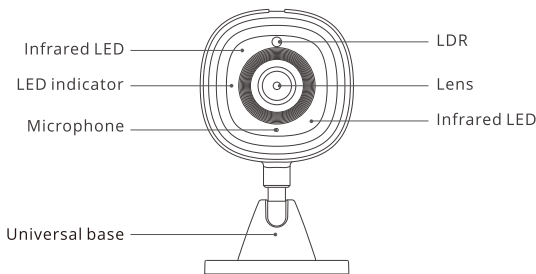

## Wi-Fi LED indicator status instruction

LED indicator status	Status instruction
Red LED indicator keeps on	Pairing mode
Red LED indicator flashed slowly	Firmware Updating
Blue LED indicator keeps on	Device is Online
Blue LED indicator flashed slowly	Network connecting, network abnormal (no WiFi/no server connection)

## Features

CAM Slim is a slim smart home security camera. After pairing it with eWeLink App, you can monitor your home situation in real time, talk remotely, set up motion detection to push notifications instantly on the App and share it with your families to control together, etc.

FHD

1080P HD images



IR night vision



Two-way audio



Motion detection



Support cloud storage



Alerts feature



Smart scene



Share control



RTSP protocol



Push notification



TF card storage

ⓘ If the TF card has been inserted, the camera will alarm and push a notification to eWeLink APP and automatically records a 30s-5mins video and stores in the TF card when motion detection is triggered.

ⓘ The TF card is required with a transmission speed of at least class10.

## Operating Instruction

### 1. Download the eWeLink App



Android™ & iOS

## 2. Power on

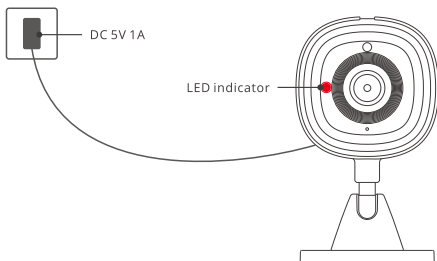

After powering on, the device is reset by default during the first use. The camera entered the pairing mode successfully when you hear the voice prompt “please use mobile phone for Wi-Fi configuration” and see the LED indicator turns to solid red.

⚠ If the camera is not be added within 5mins, it will exit the pairing mode. If you want to enter the pairing mode again, please long press the “RESET” button for 3s until you hear “Reset success”, then follow the voice prompt for the next step when the device restart.

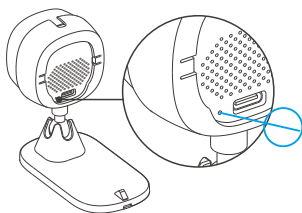

## 3. Add camera

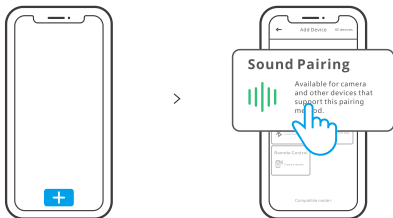

Tap “+” and select “Sound Pairing”, then operate following the prompt on the App.

## Compatible Pairing Mode

If failed to pair through "Sound pairing", please pair it via "Compatible mode":  
Set the camera in the pairing mode, click "+" on the interface of eWeLink App, select "Compatible mode", then add the device according to the prompt.

## Specifications

Model	S-CAM
Input	5V --- 1A
Interface type	Type-C
Aperture	F2.3
Resolution	1080P
Video compression standard	H.264
Wi-Fi	IEEE 802.11 b/g/n 2.4GHz
Storage methods	Cloud storage and TF card (Max.256GB for TF card)
App operating systems	Android & iOS
Working temperature	-10°C~40°C
Casing material	ABS V0
Dimension	91x53x44.5mm

## Infrared night vision

Built-in 2 infrared night vision LEDs which ensure the night vision distance of 10m. The infrared LEDs will be automatically activated in a low-light condition to provide a clear monitoring image.

## Bind camera

You can add it on the APP control page of SONOFF devices, like BASIC, S26, TX, SNZB and more after the camera is connected with the eWeLink APP.

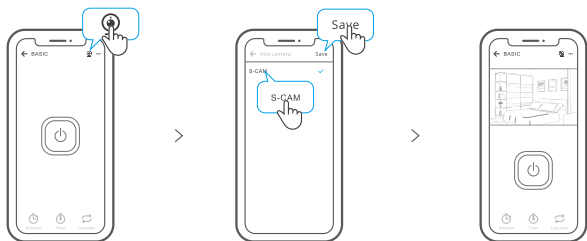

## Insert TF card

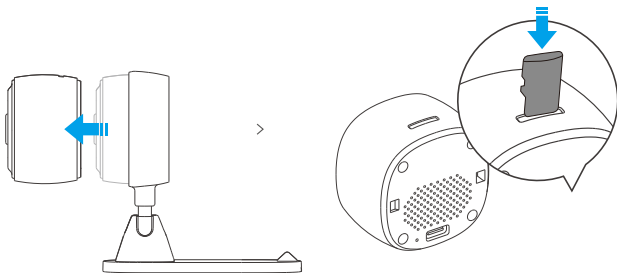

⚠ TF card is not included in the product, please purchase it separately.

## Factory Reset

Deleting the device on the eWeLink app indicates you restore it to factory setting.

## Installations methods

- ① Place on the desktop
- ② Magnetic attraction (attached to the surface of metal materials)
- ③ Stick with 3M adhesive
- ④ Fix with screws

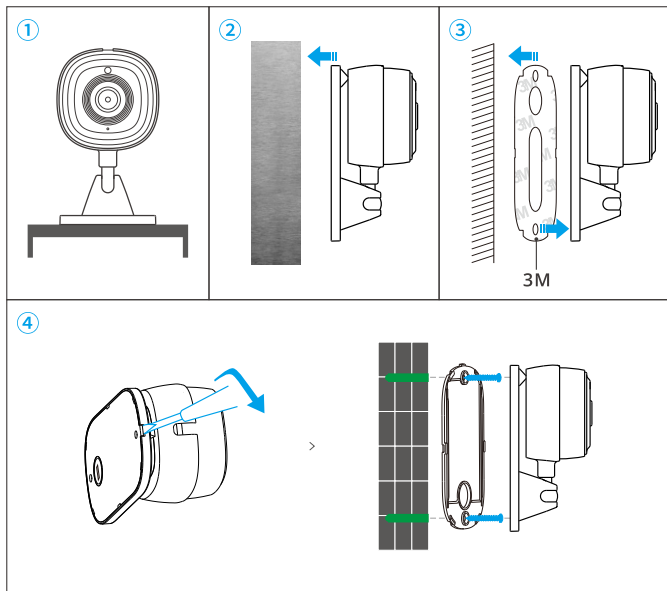

## Cautions

- Don't expose the camera to sun for very long.
- Don't get the camera wet or leave it where it can get wet.
- If videos gets blurred, please wipe the lens using a cloth with alcohol to keep clean.
- To avoid to disturb neighbors and ensure the speaker a long lifetime, please don't get motion detection alert on for very long.

## Common Problems

Q: Fail to connect Wi-Fi and pair?

A: Please check the following problems and re-add the device when you connect Wi-Fi

- ① Only support 2.4GHz Wi-Fi network. Please disable 5GHz Wi-Fi network if you use dual band router;
- ② Keep the camera closer to your router;
- ③ Please pair and connect the camera in an environment without interference.

Q: Is it normal for the speaker to make squealing sound?

A: Your smartphone and the camera maybe cause mutual interference and lead to the squealing sound from speaker when you use "Talk". Please keep your smartphone away from the camera to eliminate interference.

Q: Why there is no sound when I communicate with the camera on my smartphone?

A: Make sure that you enable "Talk" function on your smartphone. If it doesn't receive the sound from the camera, please check if the microphone is muted.

Q: How to enable "Activity detection reminder" on the eWeLink APP?

A: Tap "... " on the upper right corner on the camera page, access setting page and enable "Activity detection reminder", then select the right one from "high, medium and low sensitivity" and turn on "Sound Alert". The camera will alarm once any motion is detected.

Q: Why videos get stuck when playing?

A: To ensure videos are playing fluently, please connect broadband network. We recommend to use the uplink broadband of 2Mbps for the camera and the downlink broadband of 2Mbps for the smartphone. The videos may get stuck if the camera is connected to a Wi-Fi network that many users connected.

Q: How to avoid triggering false alarms?

A: The motion detection is used to monitor object movement rather than human movement, so ray of light, shadow of trees, flying animal can trigger activity detection reminder. To prevent triggering false alarms, please set the motion detection sensitivity the "low level".

## FCC Warning

Changes or modifications not expressly approved by the party responsible for compliance could avoid the user's authority to operate the equipment.

This device complies with part 15 of the FCC Rules. Operation is subject to the following two conditions: (1) This device may not cause harmful interference, and (2) this device must accept any interference received, including interference that may cause undesired operation.

### **FCC Radiation Exposure Statement:**

This equipment complies with FCC radiation exposure limits set forth for an uncontrolled environment. This equipment should be installed and operated with minimum distance 20cm between the radiator & your body. This transmitter must not be co-located or operating in conjunction with any other antenna or transmitter.

### **Note:**

This equipment has been tested and found to comply with the limits for a Class B digital device, pursuant to part 15 of the FCC Rules. These limits are designed to provide reasonable protection against harmful interference in a residential installation. This equipment generates, uses and can radiate radio frequency energy and, if not installed and used in accordance with the instructions, may cause harmful interference to radio communications. However, there is no guarantee that interference will not occur in a particular installation. If this equipment does cause harmful interference to radio or television reception, which can be determined by turning the equipment off and on, the user is encouraged to try to correct the interference by one or more of the following measures:

- Reorient or relocate the receiving antenna.
- Increase the separation between the equipment and receiver.
- Connect the equipment into an outlet on a circuit different from that to which the receiver is connected.
- Consult the dealer or an experienced radio/TV technician for help.



Hereby, Shenzhen Sonoff Technologies Co., Ltd. declares that the radio equipment type S-CAM is in compliance with Directive 2014/53/EU. The full text of the EU declaration of conformity is available at the following internet address:

<https://sonoff.tech/usermanuals>

The logo features the word "SONOFF" in a bold, black, sans-serif font. Above the letter "O" are three curved lines representing radio signal waves.

**Shenzhen Sonoff Technologies Co., Ltd.**

3F & 6F, Bldg A, No. 663, Bulong Rd, Shenzhen, Guangdong, China  
ZIP code: 518000 Website: sonoff.tech

MADE IN CHINA

